

LMC MODEL YEAR 2025

EN

DATE: AUGUST 2024

WE LIVE  
CARAVANNING

**LMC**

QUALITY. TRUST. AT HOME.

made in  
**GERMANY**



LMC –  
SIMPLY RELIABLE

made in  
GERMANY

[www.lmc-caravan.com](http://www.lmc-caravan.com)



## LMC INSIGHTS GET TO KNOW OUR BRAND AND LEARN TO APPRECIATE IT

LMC is the down to earth and honest brand you can rely on. With almost 70 years of caravanning experience, our staff develop modern, future-proof caravans, motorhomes and camper vans. Our design engineers rely on cleverly designed, lightweight furniture in optimum entry-level, couple and family layout versions. The well thought out mix of materials and special light engineered components result in generous user payloads. It is important to us that all LMC components are designed with a focus on durability and value retention.

Across all of our model ranges, we create clear structures and provide transparent information to make it as easy as possible for you to choose the LMC that's right for you.

Discover our LMC world.

Layout  
overviews  
Page 4 - 7

History  
Page 8 - 9

Upgrading  
Page 11

Original  
accessories  
Page 11

Information  
material  
Page 12

Dealer search  
Page 12

Sustainability  
at LMC  
Page 13

Pop-up roof  
Page 14

LMC theme world  
Page 14

LMC Home app  
Page 14

Clever solutions  
Page 15

LMC caravans  
Page 16 - 17

Sassino  
Page 18 - 19

Style  
Page 20 - 21

Tandero  
Page 22 - 23

Videro  
Page 24 - 25

Exquisite VIP  
Page 26 - 27

LMC motorhomes  
Page 28 - 29

Tourer and  
Tourer Lift  
Page 30 - 31

Tourer alcove  
Page 32 - 33

Cruiser  
Page 34 - 35

LMC camper vans  
Page 36 - 37

Innovan  
Page 38 - 39



This printed product  
has been marked  
with the Blue Angel.

# SASSINO

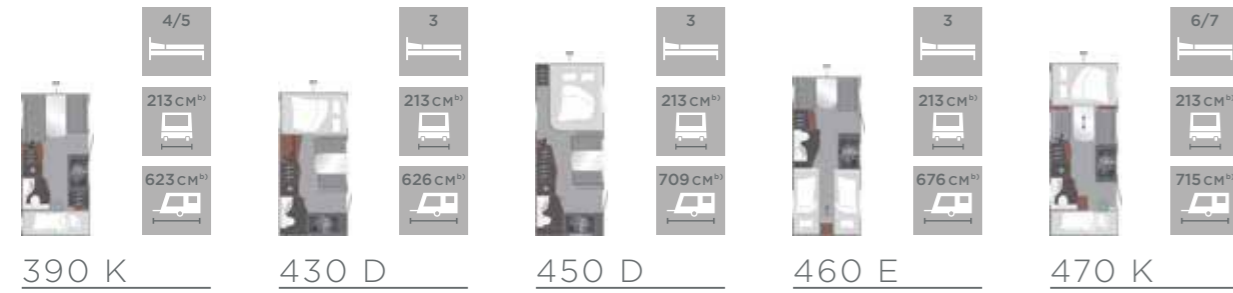

# STYLE / STYLE LIFT

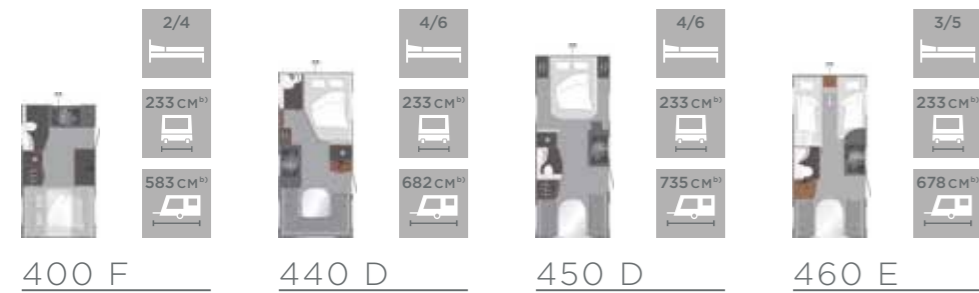

# TANDERO



# VIDERO

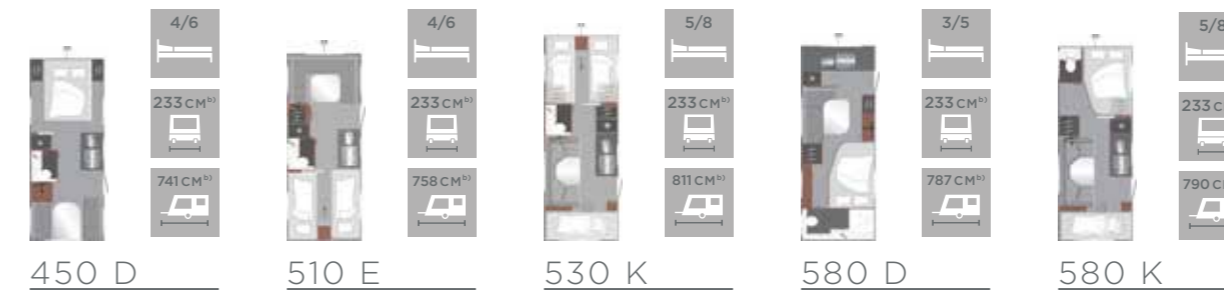



# EXQUISITE VIP

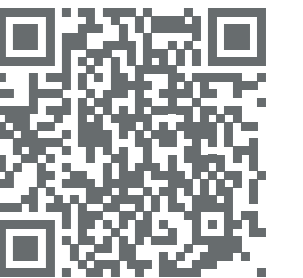

<sup>9)</sup> The dimensions stated are standard values defined in the type approval specified in the type approval procedure. Due to manufacturing tolerances, the actual dimensions may deviate from the values stated above. Deviations of up to up to ± 3% of the dimensions are legally permissible and possible. The factory-fitted installation of special equipment may the specified dimensions of the respective model or floor plan.  
Status: August 2024



# TOURER / TOURER LIFT / TOURER ALCOVE



 4/6 232 cm <sup>h)</sup> 699 cm <sup>h)</sup>	 3/5 232 cm <sup>h)</sup> 699 cm <sup>h)</sup>	 3/5 232 cm <sup>h)</sup> 737 cm <sup>h)</sup>	 4/6 232 cm <sup>h)</sup> 737 cm <sup>h)</sup>
T 630 FIAT availability request	T 660 G FIAT	T 720 FIAT availability request	T 730 G FIAT availability request

 4 232 cm <sup>h)</sup> 699 cm <sup>h)</sup>	 4 232 cm <sup>h)</sup> 699 cm <sup>h)</sup>	 3 232 cm <sup>h)</sup> 699 cm <sup>h)</sup>	 3 232 cm <sup>h)</sup> 706 cm <sup>h)</sup>	 4 232 cm <sup>h)</sup> 738 cm <sup>h)</sup>	 4 232 cm <sup>h)</sup> 738 cm <sup>h)</sup>
H 630 FIAT	H 634 Ford	H 660 G FIAT	H 664 G Ford	H 720 FIAT	H 730 G FIAT

 4/6 232 cm <sup>h)</sup> 699 cm <sup>h)</sup>
A 690 G FIAT

<sup>h)</sup> The dimensions stated are standard values defined in the type approval specified in the type approval procedure. Due to manufacturing tolerances, the actual dimensions may deviate from the values stated above. Deviations of up to up to ± 3% of the dimensions are legally permissible and possible. The factory-fitted installation of special equipment may the specified dimensions of the respective model of the respective model or floor plan.  
Status: August 2024

# CRUISER

 3/5 222 cm <sup>h)</sup> 677 cm <sup>h)</sup>	 3/5 232 cm <sup>h)</sup> 699 cm <sup>h)</sup>
V 646 G FIAT	T 662 G FIAT

# INNOVAN

 2/5 209 cm <sup>h)</sup> 541 cm <sup>h)</sup>	 2/3 211 cm <sup>h)</sup> 598 cm <sup>h)</sup>	 2/3 211 cm <sup>h)</sup> 598 cm <sup>h)</sup>	 2/5 209 cm <sup>h)</sup> 599 cm <sup>h)</sup>	 2/5 209 cm <sup>h)</sup> 636 cm <sup>h)</sup>
540 FIAT	590 Ford	592 Ford	600 FIAT	640 FIAT

# LMC

## MOTORHOME AND CAMPER VAN LAYOUTS



CONFIGURE  
YOUR LMC

# LMC JOURNEY INTO THE PAST IT ALL STARTED WITH THE „KNOSPE“



1955

In the 1950s, the master painter and varnisher – and passionate camper – Heinrich Austermann develops a folding camper trailer for his own use. Due to popular demand, he begins to manufacture the legendary „Knospe“ in 1955.



1966

Wilhelm Saure takes over the company and establishes the Wilhelm Saure KG. The first caravan goes into serial production.

Until the mid-1960s, Heinrich Austermann produces various versions of the „Knospe“ with his fifteen employees.



1976

The legendary model ranges „Lord“ and „Münsterland“ are launched in the 1970s. The 10,000th caravan rolls off the production line in 1976.



1986

In 1981, the company becomes the „LMC Lord Münsterland Caravan GmbH“. The first „Liberty“ model range motorhomes roll off the production line from 1986 onwards.

1991



The company's incorporation into the Erwin Hymer Group leads to investments into the factory's expansion.

2000 – 2005

LMC invests in a customer service centre, new production and logistics facilities, plant and machinery. The factory uses Ford Transit chassis for the first time.



2015

LMC celebrates 60 years of passion for caravanning and launches two attractive special edition caravan and motorhome models.



2007 – 2013

In order to further optimise the LMC brand, the production area is restructured, and investments are made into a water jet cutting machine, a roof production line, an edging centre and hail-proof roofs.



2018

Opening of the new production facilities that double the production capacity. The state-of-the-art technology represents a milestone in the LMC company history.



2020 – 2024

The 65th company anniversary in 2020 marked the beginning of a transformative phase. With the logo relaunch in 2021, right in the middle of the Covid pandemic, LMC began to pursue a new, forward-looking strategy. That same year, the company started to produce camper vans. In 2024, LMC also launched a new over-cab alcove bed model, after a break of several years.



made in  
**GERMANY**



## QUALITY YOU CAN DEFINITELY RELY ON

LMC stands for outstanding quality, reliability and long-lasting value. We use advanced production technologies to be able to guarantee all three. For added security, we give you our unique quality promise: a twelve-year water ingress warranty.<sup>a)</sup>

<sup>a)</sup> All LMC caravan and motorhome bodies come with a twelve-year water ingress warranty, provided the vehicle is serviced annually by an official LMC partner (service charges apply). Please note that this warranty only applies to motorhomes up to a maximum total mileage of 120,000 km.

## MANUFACTURER STANDARD ACCESSORY RETROFITTING BY LMC CARAVAN IN SASSENBERG

Did you know that you can also have accessories retrofitted to your vehicle by us at our factory? At our customer service centre in Sassenberg, we offer you this service for anything from a bike carrier to a DuoControl system for the gas cylinders, all fitted to manufacturer standard and in manufacturer quality. Maybe you have realised you need additional accessories after your first few trips? We are happy to check whether the accessories you would like can be retrofitted and to provide a quote; simply contact us via the QR code below and we will get in touch with you.



## ORIGINAL ACCESSORIES FOR YOUR LMC: GUARANTEED TO FIT

Discover our original accessories and extras for the perfect camping holiday in your LMC! Get some inspiration from our products in the following categories:

- Vehicle interior and exterior ■ Multimedia ■ Safety
- Utilities ■ Comfort ■ Merchandise

Our dealers will be happy to contact you, and to handle the ordering process for you.

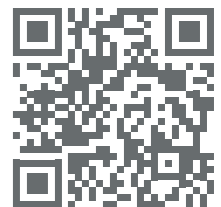



## FIND A DEALER NEAR YOU

The practical dealer locator on our website and in the LMC Home app makes finding your nearest LMC dealer quick and easy. Simply enter your postcode for an overview of LMC dealers near you. Regardless of whether you are thinking of purchasing a caravan or a motorhome, or whether you are simply looking for a particular service or spare parts - our dealers are by your side with their expertise and willingness to help.



## WELL-EQUIPPED AND WELL-INFORMED

Discover the range of free information material available from our website, from catalogues and leaflets to price lists, and including technical specifications and instruction manuals. Get to know your LMC even better with our informative brochures, and be perfectly prepared for your next holiday. Downloading the material is quick and easy - do it now!



### IMPORTANT NOTES

<sup>1)</sup> The dimensions stated are standard values defined in the type approval specified in the type approval procedure. Due to manufacturing tolerances, the actual dimensions may deviate from the values stated above. Deviations of up to  $\pm 3\%$  of the dimensions are legally permissible and possible. The factory-fitted installation of special equipment may affect the specified dimensions of the respective model of the respective model or floor plan.

All technical specification details and dimensions as well as all features and finishes stated in this print publication reflect the latest information and the production status on the publication date (August 2024). At all times, LMC Caravan & Co. KG reserves the right to make changes or improvements to the product. We therefore recommend that you refer to our website, use our configurator and/or contact your authorised LMC dealer to find out about any potential changes compared to this publication when you are gathering information and prior to signing any agreement.

Decorations shown not included.  
Some of the images show extras that are not included.

All colours may be subject to change; errors and omissions excepted. Please note that for printing or lighting reasons, colours may vary slightly from those shown.

Valid from August 2024.

## SUSTAINABILITY AT LMC

As a manufacturer, we are aware of our environmental protection responsibilities. Only an intact environment can safeguard the future of our industry, and only an intact environment makes it possible for us to provide our customers a carefree holiday experience in their home on wheels.

We promote sustainable business practices, and make a positive contribution to the environment, society and the economy. We have embedded the building blocks of resource conservation, focusing on our employees, product developments, transparency and corporate responsibility in our sustainability guidelines.

Some examples at LMC:

In the vehicle area

- Clever light construction concepts and up-to-date emission standards
- Focus on high-quality light construction inside the vehicle
- Flat, aerodynamic body for lower air resistance
- Use of sustainable materials, e.g. for the upholstery fabrics and curtains
- Value retention and product durability

In the production area

- Biomass heating system and modern ventilation systems
- Carbon neutral by-products (e.g. wood chips) from the production area are used for heat generation
- Ventilation systems with heat recovery in the works
- Target of carbon neutral production by 2030
- 100% green electricity supply and energy-saving LED lighting

In the communication area

- Blue Angel eco-label print catalogues (choice of paper and printing process)
- Awareness of our responsibility for our staff and for society
- Team qualification and further development through in-house LMC training centre
- Being a dependable partner for: our staff, dealers, collaboration associates and suppliers
- Promoting sustainable solutions: investing in sustainable projects in order to minimise the impact of our actions on the environment



This printed product has been marked with the Blue Angel.





## HIGH AND DRY: THE CLEVER WAY TO TRAVEL

The LMC pop-up roof not only adds two further berths, but also creates a cosy den that is much appreciated by children and adults alike. Our layouts with beds designed especially for children feature a classic bunk bed as a standard; this can optionally be increased to a triple bunk bed (due to the angled rear, not possible in the Style Lift 500 K).



## CAMPING TIPS AND INSIDER KNOWLEDGE

Welcome to the LMC world! In our company blog we regularly provide exciting content for you: not only news from the LMC works, but also a look behind the scenes, as well as useful expert tips and inspiring stories from the world of camping.

Learn more about our production facility in Sassenberg; read travel reports written by enthusiastic campers, and receive valuable tips on how to look after your caravan or motorhome. The LMC world is a source of information, but also an inspiring place for everyone who wants to learn more about our brand.



## LMC HOME: SMART LIVING

For increased safety, comfort and an even better connection to your caravan. Via the LMC Home app, you are in direct contact with your vehicle. Keep an eye on the fill level of your tanks, the tyre pressure, the room temperature, or also your noseweight at all times. The required LMC Home box and sensors are available from our original LMC accessory shop on the LMC website. The model ranges Tandero and Videro are already equipped with the LMC Home box, including the levelling sensor; the Sassino and Style are LMC Home-ready, i.e. equipped with everything that is needed to fit this optional extra. Get tips and tricks on camping, and use the additional information in the app to quickly find the nearest service partner, for example.

\* Can only be used within Bluetooth range

## A SELECTION OF OUR CLEVER SOLUTIONS



- Keep an eye on your moving home from home at all times with the LMC Home App.
- Tinted and double-glazed windows keep the heat in and the noise out – and ensure more comfort and privacy, optimum insulation as well as higher energy efficiency.
- All of our vehicles are equipped with shock absorbers for additional stability and safety. This ensures that you'll get 100 km/h approval.
- The lowered rear creates a generously-sized storage space with a user payload of up to 250 kg. You can therefore also easily carry larger items in your motorhome.
- Thanks to a fresh water tank volume of 100l (model-dependent), you'll also have a sufficient store of water on board for longer trips. The large 90l grey water tank in our motorhomes and camper vans ensures longer self-sufficiency.

- The practical folding bed in the Style 400 F gives you more space during the day and ensures that you get a good night's sleep at night. Converting it is effortless and easily done.
- The standard drop-down bed in the Style Lift represents another innovative bed solution.
- Our sustainable upholstery fabrics made from recycled PET (Sassino, Style, Videro and Tourer alcove) are not only eco-friendly (Style and Tourer alcove) but also easy to clean and maintain.
- Our overhead lockers are back-ventilated to ensure that the air can circulate.
- Our various lighting concepts create a relaxed and cosy, really homely atmosphere.



- Cooking with gas or induction – the three burner stove (2x gas, 1x induction) in the Videro caravan offers you a choice.
- The practical rails with hooks and the spice rack ensure that your kitchen utensils are always on hand and at the same time stored in an orderly way.
- The large soft-close kitchen drawer provides plenty of storage space for your stores, ingredients and more.
- The modern lighting panel ensures perfect lighting conditions when cooking.

- The slatted bed bases with disc springs in our Videro offer a high level of sleeping comfort. Comfortable viscoelastic foam mattresses complete the relaxation concept.
- Thanks to a gas spring mechanism, our fixed beds can be lifted up safely, which makes it easier to load the vehicle.
- Perfect lighting in the evening thanks to our power track for flexible reading spots.
- More space for showering – the Innovan 592 is equipped with a swivel toilet that disappears underneath the single bed.





ENJOY THE  
CARAVANNING LIFESTYLE

## HITCH UP, GET ON THE ROAD AND FEEL AT HOME

Our portfolio offers a wide range of caravan models that stand for maximum comfort, quality and reliability. Holiday in the countryside and dinner in the city in the evening? No problem with a car and caravan outfit! Your LMC caravan will accompany you to wherever you'd like to travel. Discover our caravan portfolio, and find the model that perfectly meets your ideas and requirements.

### OUR MODEL RANGES

- Sassino: Entry-level model for young couples and families – particularly slimline and lightweight, with a sleek and contemporary design in matching shades
- Style: Entry-level family companion – compact with a spacious feel and a Scandi-style interior
- Tandero: New addition with a focus on couples – Japandi-style interior
- Videro: Premium comfort for couples and families – with a sophisticated ambience
- Exquisite VIP: Premium caravan – stylish elegance with a length of up to 9.57m<sup>b)</sup>

### CARAVAN EXTRAS

- Our layouts with beds for children offer the option of choosing a triple bunk bed (due to the angled rear, this is not possible in the Style Lift 500 K).
- Add framed windows – they add a dynamic touch to your caravan exterior.
- Upgrade your caravan even more with optional alloy wheels.
- The optional pop-up roof creates an additional space with two berths (model-dependent).
- The kitchen can optionally be equipped with an oven (layout-dependent).

made in  
**GERMANY**

FIND MORE INFORMATION  
ABOUT OUR CARAVANS HERE.





The five compact layouts offer up to seven berths in single, double or bunk beds. The interior features a trendy design in matching shades. Matt black accents add a striking note to the caravan. Its muted colours and small archway elements create a timeless and contemporary look that goes with any colour. Turn your caravan into your home on wheels.

The Sassino's appealing exterior is due to the LMC family front end design. Thanks to the lightweight chassis, this electric car-friendly model range can be towed by an electric car.

The family model 470 K impresses with a raised transverse double bed at the front and an optional triple bunk bed in the rear. Like the 430 D layout, the 450 D model with a rear kitchen also offers plenty of freedom to move while cooking.



## THE VERSATILE ENTRY-LEVEL CARAVAN: **LMC SASSINO**

- Five Sassino layouts
- Layouts with single, double and bunk beds for children
- Up to seven berths

SASSINO  
PRICE LIST



### HIGHLIGHTS

- Can be towed with an electric car, thanks to slimline body and low standard weight
- Minimalist exterior design ensures a unique and memorable look.
- New family design front end
- Hammered finish side walls
- Trendy understated colours with black accents on the inside; customisable according to your own taste
- Curtains and upholstery fabrics made from recycled material
- LED touch panel in the kitchen
- Compressor refrigerator
- Optional triple bunk bed
- Dimmable bunk bed light „Dimmy“, including USB socket
- Service hatch a standard feature
- Numerous large windows create a bright atmosphere flooded with daylight.
- Everyone can come along – the bunk beds for children have a weight capacity of 80 kg, so even older children can sleep in them comfortably.
- Plenty of room for all of the important holiday accessories thanks to spacious cupboards.
- TV-readiness ex-factory option provides the basis for on-board entertainment.

### UPHOLSTERY

Andesit



Calcit



# FLEXIBLE FAMILY HOLIDAY ALL-ROUNDER: LMC STYLE

- Eight Style layouts
- Layouts with single, double and bunk beds for children, lift and fold down bed
- Up to eight berths
- Optional pop-up roof



In the Style, an oak finish has been combined with a soft sage and a concrete-look floor. The light-coloured as well as matt black accents make this model a real eye-catcher. Besides a modern, Scandinavian charm, the flexible all-rounder in the „Style Lift“ layout 500 K (which always comes with a drop-down bed) offers space for up to seven overnight guests and plenty of room to cook, play and relax.

„Easy-Clean“ upholstery fabrics (which are particularly easy to clean and very robust) as well as fabrics made from recycled PET bottles emphasise the Style's uniqueness.



## HIGHLIGHTS

- Minimalist exterior design ensures a unique and memorable look.
- Family design front end
- Hammered finish side walls
- Optional pop-up roof
- Modern Scandi-look interior
- Calm colour ranges with matt black elements
- Extremely spacious feeling
- LED touch panel in the kitchen
- Compressor refrigerator
- Indirect lighting in the fabric wall panel above the bed
- 100% linen roller blinds
- Upholstery fabrics made from recycled PET bottles with „easy clean“ finish
- Unique habitation concepts with innovative bed solutions: a folding bed that can effortlessly be folded away or down as needed (400 F), or the drop-down bed that is always included in the Style Lift (500 K).
- Flexible fitted solutions such as the pull-out sink create plenty of room (440 D).

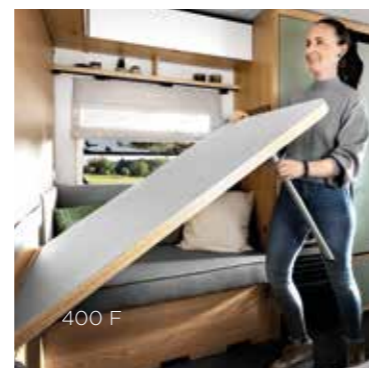

STYLE  
PRICE LIST



## UPHOLSTERY

Dunit



Fenit



The modern „Japandi“ design in a taupe finish creates a fantastic ambience by cleverly combining square with round elements. Experience the cosy atmosphere at sundown as night falls, and wake up relaxed at sunrise.

The Tandero offers five layouts in total, including one with beds for the kids. With its spacious dinettes and four potential single and double bed sleeping berths, it also offers plenty of space for guests.

Together with the handleless furniture (including anti-fingerprint coating and soft-close drawers), the natural fibre blinds and open shelves emphasise the particularly characterful combination of shapes and materials. Upholstery in stone and sandy shades creates a calm ambience inside the Tandero and makes it incredibly easy to personalise with your own choice of decorations.



TANDERO PRICE LIST



## PARTICULARLY CHARACTERFUL: LMC TANDERO

- Five Tandero layouts
- Layouts with single, double and bunk beds for children
- Up to eight berths
- Optional pop-up roof



### HIGHLIGHTS

- Minimalist exterior design ensures a unique and memorable look.
- Family design front end
- Hammered finish side walls
- Optional pop-up roof
- Modern Japandi-look interior design (Scandinavian sleekness coupled with round Japanese elements)
- The understated colours ensure that customers can personalise the interior with their preferred accent colours.
- Fabric wall panel with sunrise
- LED touch panel in the kitchen
- Compressor refrigerator
- Modern washroom with countertop basin and towel rail below the overhead locker
- 100% linen roller blinds
- Extensive indirect lighting (extra pack)
- Clever and at the same time practical: the new vanity unit in the washroom provides even more comfort and room to move.
- Thanks to an optional triple bunk bed in the rear, the Tandero 500 K layout family model easily sleeps up to five people.
- Elegant details such as the round mirror in the entrance area ensure that you live and feel like you're at home (layout-dependent).
- The practical, wall-mounted round felt organiser is easily detachable and can be carried like a bag.
- Various shelves and convenient USB charging points ensure that the sleeping area is a comfort zone.



500 E



500 K



500 E



### UPHOLSTERY

Dolerit



Runit





# FOCUS ON CHARACTER AND COMFORT: **LMC VIDERO**

- Five Videro layouts
- Layouts with single, double and bunk beds for children
- Up to eight berths
- Optional pop-up roof

VIDERO  
PRICE LIST



510 E



580 K



580 D

With its striking front and rear pillars and the matt black rear end grab rail, the Videro's exterior differs from the other LMC caravans. Numerous standard features provide that little bit of extra comfort. A full GRP body, framed windows with linen roller blinds, a fly screen door and heavy-duty supports for more stability are just some of the exterior standard feature highlights. The habitation inside is clearly above-standard. The Videro features a contemporary Japandi design, perfected with sophisticated furniture accents. The integrated LMC Home Box, a standard feature, as well as the comfortably upholstered backrests, the high-quality beds, the trendy kitchen design, the hybrid cooker with induction and the indirect lighting including a rising sun ensure that comfort is the norm inside the Videro.



510 E

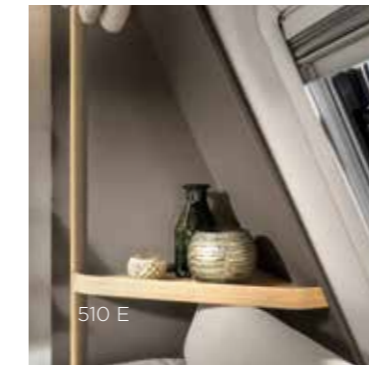

510 E



## HIGHLIGHTS

- Comfort model range
- Exterior features moulded front and rear pillars
- Alloy wheels
- Optional pop-up roof
- Winter-proof thanks to Combi 6 heating
- Comfortable access thanks to wide habitation door
- Modern Japandi-look interior design (Scandinavian sleekness coupled with round Japanese elements)
- The understated colours ensure that customers can personalise the interior with their preferred accent colours.
- LED touch panel in the kitchen
- Compressor refrigerator
- Wall blind with sunrise
- Modern washroom with countertop basin and towel rail below
- 100% linen roller blinds
- Upholstery fabrics in earthy shades made from recycled PET bottles
- Extensive indirect lighting
- Sit flexibly thanks to the practical divided backrest cushions (450 D)
- Extra-large overhead lockers provide more storage space
- Overhead locker doors with a decorative groove for a sophisticated feel to the touch
- The washroom offers plenty of room, and considerable comfort whilst „freshening up“ thanks to the large mirrors.
- The practical, wall-mounted round felt organiser is easily detachable and can be carried like a bag.

## UPHOLSTERY

Dravit



Selenit





The Exquisite VIP stands for luxury: roller blinds, cooker with oven, slatted bed bases with adjustable head sections, alloy wheels, top-class equipment and high-quality furniture are just some of its highlights. Experience the outstanding spaciousness of the VIP, thanks to a vehicle width of 2.53 metres<sup>b)</sup> and a length of up to 9.57 metres<sup>b)</sup>, layout-dependent.

Together with the illuminated display case, the indirect lighting creates a pleasant, luxurious ambience that invites you to travel in comfort.

Sleep like you're on cloud nine: Thanks to the comfortable beds with adjustable head ends. The slatted bases can also be individually adjusted. The VIP's spacious washroom impresses with numerous standard features such as a generously-sized separate toilet space and a smart wood finish cupboard with shelves. There is also plenty of light thanks to an integrated roof vent equipped with a combination blind. Enjoy your time out in a luxurious ambience.



## STYLISH AND ELEGANT: LMC EXQUISITE VIP

- Four Exquisite VIP layouts
- Double bed layouts
- Up to five berths



EXQUISITE VIP  
PRICE LIST



### HIGHLIGHTS

- Premium class
- Fine hammered finish side walls
- Alloy wheels
- Decorative black roof rail
- Extremely spacious feel
- High gloss flap doors
- Soft-close drawers
- Cooker with oven
- LED touch panel in the kitchen
- Large refrigerator a standard feature
- Indirect, dimmable lighting creates a cosy ambience
- Vegan leather
- Slatted bed base with adjustable head section
- Cold foam mattresses on the fixed beds
- Wooden sliding room divider doors

### UPHOLSTERY

Swan





SIMPLY TAKE OFF  
TO WHEREVER  
YOU'D LIKE TO GO

## THE SPONTANEOUS AND FLEXIBLE WAY TO TRAVEL

Independent and safe travel with an LMC motorhome – from a day trip to an annual holiday lasting several weeks. You'll always have your home away from home with you. When you want to experience a different place, you move on in comfort. In a motorhome, you are your own boss, without set check-in and breakfast times or the bother of lugging suitcases around. Instead, you can take your pet, sports equipment and your own bed along. Discover our Cruiser and Tourer model ranges now – your reliable companions on the road. For wonderful holidays that make you happy.

### OUR MODEL RANGES

Tourer, Tourer Lift and Tourer alcove:  
Cruiser:

The entry-level model for couples and families – particularly lightweight and low  
Sophisticated model range that mainly appeals to couples – comfort and flexibility, also available as a van

### MOTORHOME EXTRAS

- Our pop-up roof adds even more space to your moving home from home (model-dependent). It is not only popular with children, but also with adults.
- The optional awning on our Tourer models shields you from the sun and creates another room.
- Framed windows are quieter (less wind noise) and safer than windows without a frame. They also add a sophisticated look to your motorhome.
- The aspects which the Tourer model range particularly focuses on are a lightweight construction and a low vehicle height.

made in  
**GERMANY**

FIND MORE INFORMATION  
ABOUT OUR MOTORHOMES HERE.





# READY FOR ALL TRIPS: THE LMC TOURER MODELS

- Eleven Tourer, Tourer Lift and over-cab alcove bed models
- Single and double bed layouts, models with a drop-down bed or an over-cab bed in the alcove
- Two chassis versions
- Up to six berths
- Optional pop-up roof (except on the Lift models and the over-cab alcove bed model)

TOURER  
PRICE LIST



The model range is available in a total eleven different layouts – six of these are Tourer Lift versions, which are equipped with a practical drop-down bed. The sleek design of the interior looks bright and modern. The light oak finish furniture is perfected by matt white and taupe accents. The Ford-based layouts H 664 G and H 634 stand out due to their dynamic look, and the fact that they are equipped with a diesel heating system as a standard feature.

The seamless flow between the passenger compartment and the habitation area that is typical LMC, the wide habitation door, the diesel heating system as a standard feature well as the practical pull-out stool meet all comfort needs and create a cosy ambience. In the Tourer model range, the dinettes are created by swivelling the front seats around to face a two-seater bench with ergonomic upholstery; there is also an additional seat (modeldepending) that provides space for one more companion.

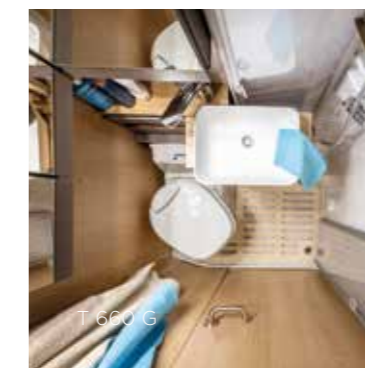

## HIGHLIGHTS TOURER AND TOURER LIFT

- Focus on light construction
- Winter-proof
- Super spacious feel
- Timeless, modern design with understated colours so customers can add a personal touch.
- Handleless furniture design
- Taupe anti-fingerprint finish
- Sink cover can be stowed away by hanging it inside the cupboard door
- Large compressor refrigerator
- Cold foam mattress
- Additional cushions for making up an occasional bed (not on the Lift models)
- Modern washroom with countertop basin
- Indirect lighting inside the overhead lockers and the bed section (Tourer Package)
- The practical washroom layout ensures that there is ample space
- From compact to generous: Our single beds feature a rollaway mechanism that makes it easy to connect them to create one large bed.
- Everything well-organised: No problem, thanks to the extra-wide, lit wardrobe.
- The Tourer Lift's electric drop-down bed disappears inside the roof.
- Combination blinds in the sleeping area create the necessary level of privacy.
- Movable sink creates more space and makes it easier to use the toilet (layout-dependent).

## UPHOLSTERY

Mercury



Moon





The LMC Tourer over-cab alcove bed model A 690 G is built for families. Up to six people find plenty of space in the Tourer alcove on the road and at night. Thanks to its light construction design and a gross vehicle weight of below 3.5t, it is an attractive holiday companion for younger families, as it can be driven with a category B driving licence. Here, efficiency and comfort go hand in hand. The bed in the alcove above the cab provides a comfortable and generously-sized berth for two people.

The Tourer A 690 G is a highlight, as it offers so much value for the money. Its standard features are unparalleled: a full GRP body, a reversing camera and a rear garage with a high user payload are just some examples of its impressive details. The high-quality upholstery fabrics are made of 100% recycled PET with an „easy clean“ finish and complement the understated interior design; they are not only eco-friendly, but also easy to look after and durable.



## TRAVELLING IN THE BEST OF COMPANY: LMC TOURER OVER-CAB ALCOVE BED MODEL



TOURER ALCOVE  
PRICE LIST



### HIGHLIGHTS TOURER ALCOVE

- Focus on light construction
- Winter-proof
- Super spacious feel
- Handleless design
- Taupe anti-fingerprint finish
- Six-seater/six berth version can be driven with a category B driving licence thanks to a gross vehicle weight of below 3.5t
- Alcove design provides a comfortable berth above the cab with a sleeping area measuring 213x140 cm
- Full GRP shell (side walls, floor, roof and rear wall) offers protection and increases the lifespan
- Six-seater (six seats fitted with seat belts)
- Generously-sized wet room with separate shower and toilet area.
- Stand-out vehicle in the 3.5t class due to LMC's light construction method, the compact dimensions and the fact that it is a six-seater.
- Truma Combi 4D diesel heating system standard feature permits all-year-round use
- The 131l compressor refrigerator also works reliably in hot weather
- High user payload in the rear garage (250 kg) and good load restraint thanks to lashing rails.
- Swivel cab seats
- Lit rear garage with 230V socket



### UPHOLSTERY

Rhyolith



# FLEXIBLE AND RELIABLY BY YOUR SIDE: LMC CRUISER

- Two Cruiser layouts
- Single bed layouts
- Fiat chassis
- Up to five berths
- Optional pop-up roof



Our spacious Cruiser sleeps up to four people. The L-shaped dinette easily converts into another sleeping berth.

The sophisticated real oak look of this motorhome leaves nothing to be desired for active holidaymakers or gourmets on the move. The Cruiser is available as a normal low profile (semi-integrated) and as a more slimline van model.

In addition to the practical swivel toilet that can be turned to the spacious bathroom the Cruiser offers a high level of comfort and plenty of freedom of movement. Fold-out laundry rails in the toilet area or in the shower provide a place for drying wet clothes.

Numerous storage solutions, like a compartment underneath the floor and the storage space below the bench seat, also ensure that you'll never be short of storage space in the habitation area when it comes to storing your travel equipment.



## HIGHLIGHTS

- Rounded, aerodynamic side wall outline
- Slimline body width
- Winter-proof
- High-quality and friendly interior design
- Handleless design
- Cold foam mattresses
- Beds with gas spring lifting mechanism
- Additional cushions for occasional bed
- Panorama window above the cab
- Framed windows
- Dimmable ambient lighting
- Heated and insulated fresh and grey water tanks
- SAT-, air conditioning-, solar panel-ready, including roof reinforcement
- Whether used as a single bed or extended to create a wide double bed – the cold foam mattresses ensure that you get a good night's sleep and are ready for the next day's adventures.
- Indirect lighting above the overhead lockers creates a warm and cosy atmosphere.
- Practical charging options where they're needed most, thanks to the flexible USB sockets for the lighting rails in the dinette and in the sleeping area.
- The practical swivel toilet is the best example for the efficient use of the washroom space.

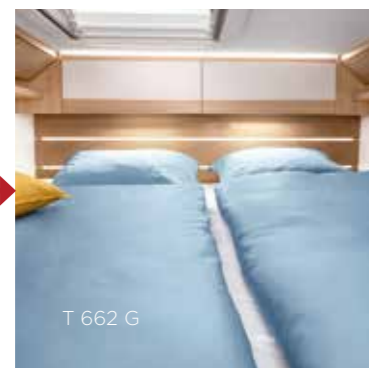

CRUISER  
PRICE LIST



## UPHOLSTERY

Deep Stone



Light Stone



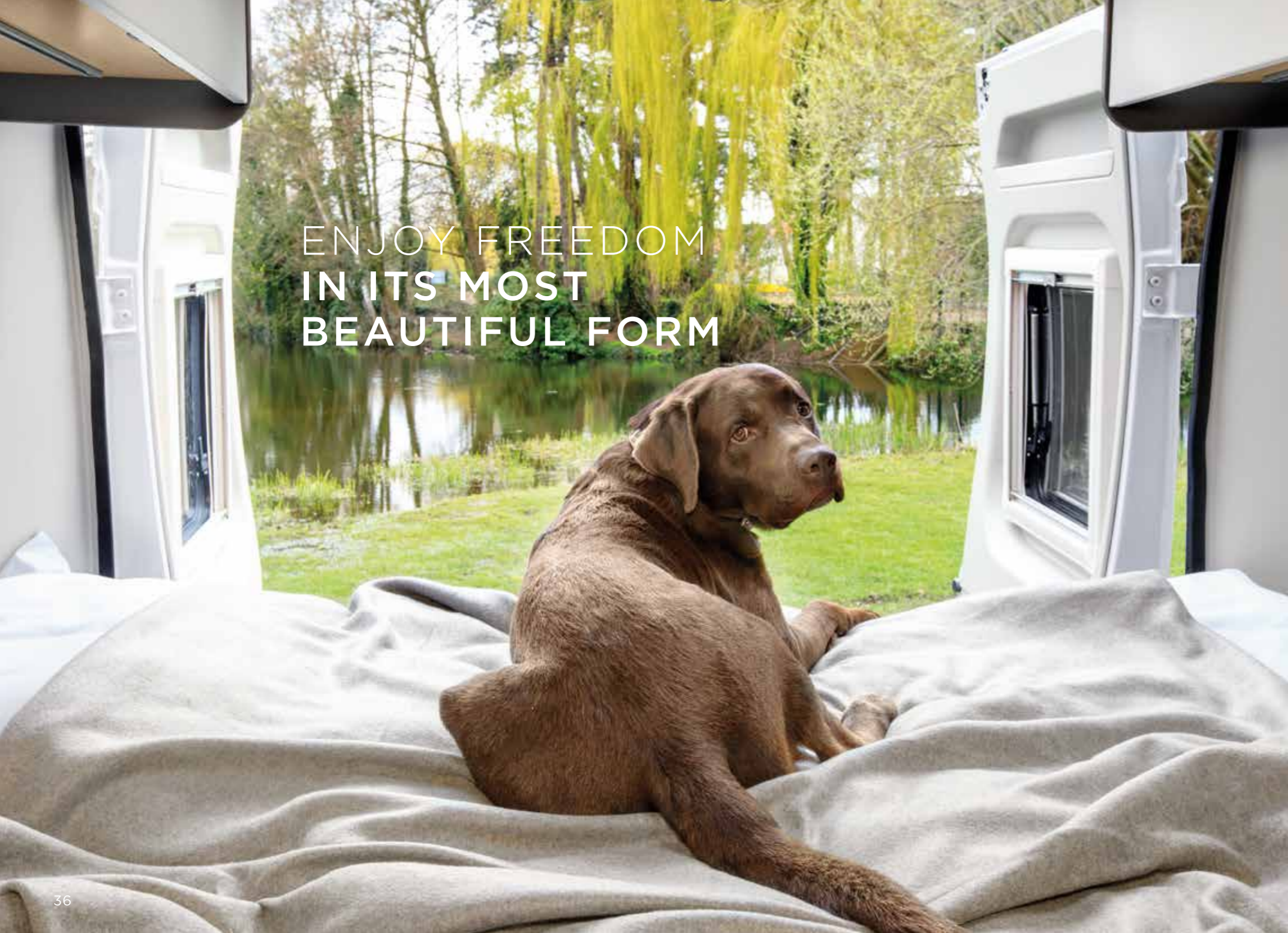

ENJOY FREEDOM  
IN ITS MOST  
BEAUTIFUL FORM

## THE CAMPER VAN, THE MOTORHOME'S „LITTLE BROTHER“

LMC's camper van is all about suitability for everyday use. The Innovan is compact enough for a quick city sightseeing detour, and at the same time offers plenty of space for comfortable and independent travel. Particularly adventurous and active holidaymakers appreciate the compact size (starting from a length of 5.4 metres<sup>9)</sup>) for city trips or outings into the countryside. Spontaneously travelling to „wherever the wind takes you“ or following a pre-determined route - „van life“ makes it possible!

Our Innovan model range consists of five Fiat- and Ford-based layouts. Experience the unique feeling of freedom offered by our LMC Innovan, the most compact vehicle in the LMC product portfolio!

### CAMPER VAN EXTRAS

- Enjoy almost 360-degree views from inside our Innovan's exclusive pop-up roof (model-dependent).
- The dinette can optionally be converted into a bed to provide a berth for an additional person.
- Equip your Fiat Innovan with our component-based carrier rack system Backrack+ to gain additional exterior transport capacities.

made in  
**GERMANY**

FIND MORE INFORMATION  
ABOUT OUR CAMPER VANS HERE.





# TIMELESS TOURING: LMC INNOVAN

- Five Innovan layouts
- Single and double bed layouts
- Two chassis versions
- Up to five berths
- Optional pop-up roof

INNOVAN  
PRICE LIST



590



592



592

The Innovan combines a sporty character with a dynamic design and a structured design language: Young, fresh and stylish. The interior features a light oak finish combined with a modern taupe, which adds calm to the space.

With its five Fiat- and Ford-based layout versions, it offers two to five berths in a double bed, single beds or the pop-up roof. Especially kids love this cosy den on the roof, panoramic views included (layout-dependent).

The new Innovan 592 impresses with a length of less than six metres<sup>b)</sup>, its single beds and the kitchen and washroom concept, including a swivel toilet and a fold away sink.

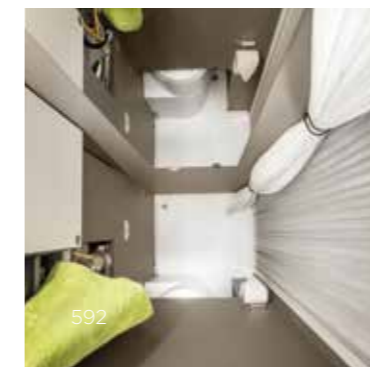

592

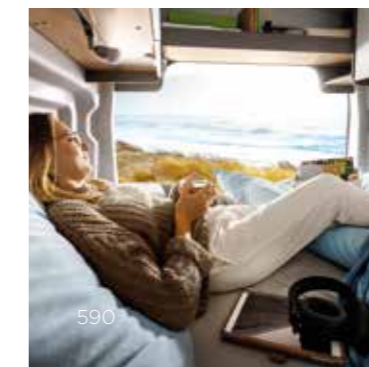

590

## HIGHLIGHTS

- Winter-proof
- Taupe anti-fingerprint finish
- Handleless design
- Rear bed with slatted base section (layout-dependent)
- Concertina washroom door for more space in the passage
- Panorama window a standard feature
- Powerful maintenance-free AGM habitation battery (95Ah) including charger (18A)
- Windows in both rear doors
- Additional storage lockers as well as open shelves above the bed offer plenty of space for your holiday accessories.
- The interior headroom in the Ford-based models also makes these suitable for tall people.
- Additional space gain of ten centimetres in the Ford thanks to sleeping extension: it increases the size of the area available for the mattress to 2.02 metres.
- Flexible kitchen solution with a movable worktop that can conveniently be pulled out for cooking (592).
- The energy-saving compressor refrigerator (up to 69l) offers flexible access as it can be opened from either side.
- Universal hook-on tracks with spice shelves and hooks in the kitchen keep everything in order.
- Stylish captain-style front seats ensure comfortable travel even on longer journeys.

## UPHOLSTERY

Granit



Natura



SEE YOU!



made in  
**GERMANY**

LMC CARAVAN GMBH & CO. KG Rudolf-Diesel-Straße 4 D-48336 Sassenberg  
T +49 (0) 2583 / 27-0 E info@lmc-caravan.de H www.lmc-caravan.com  
Münster (Westf.): HRB 9914 USt-IdNr. 126 733 941 General Managers: Bodo Diller, Timo Ecke



This printed product has been marked with the Blue Angel.

QUALITY. TRUST. AT HOME. **LMC**